

# INSTALLATION GUIDE

## PARTS

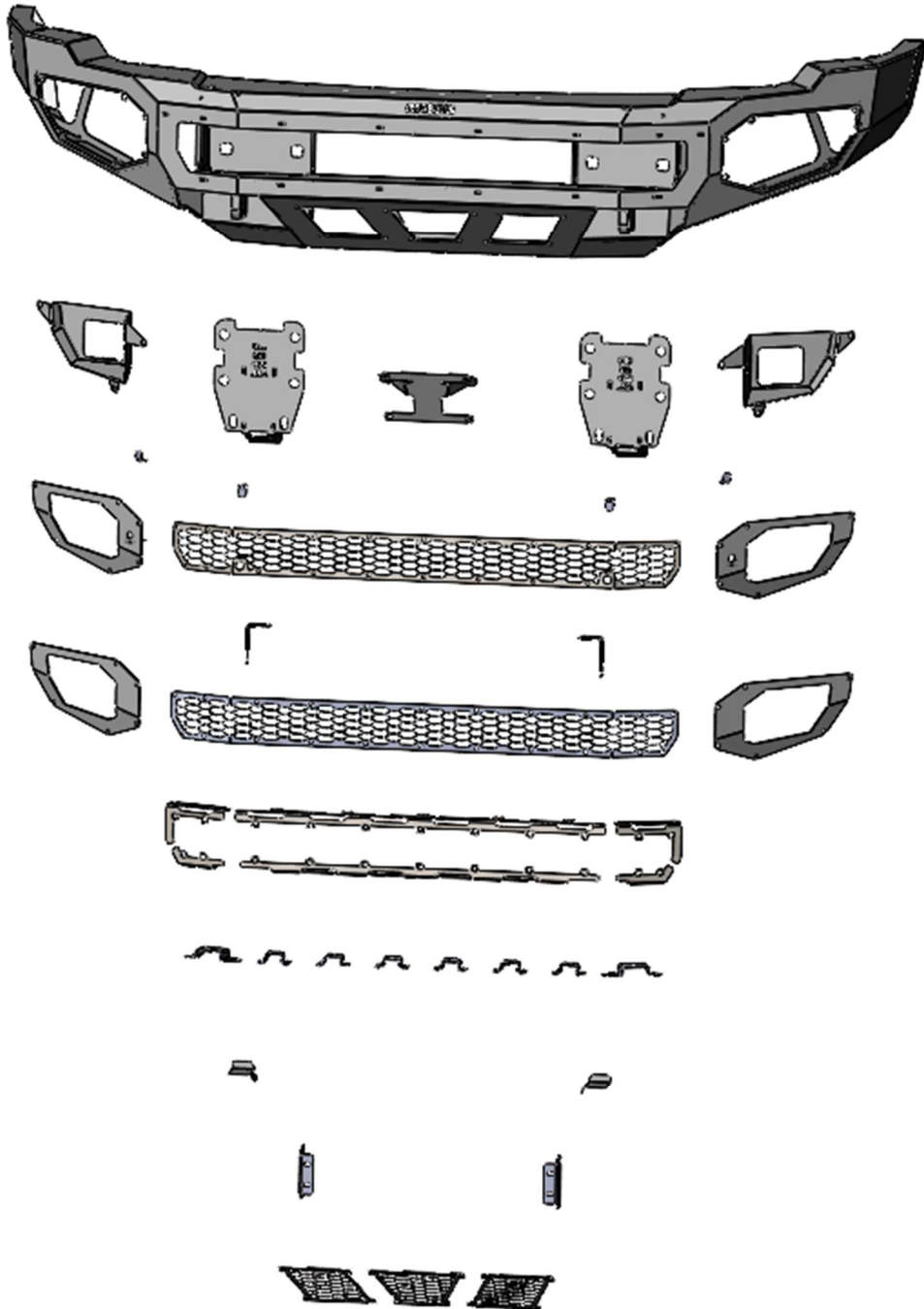

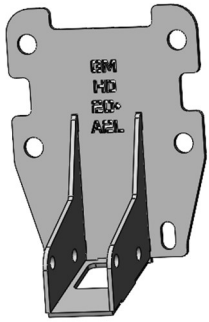

Truck Mounts x2

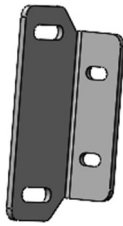

Intercooler Mounts x2

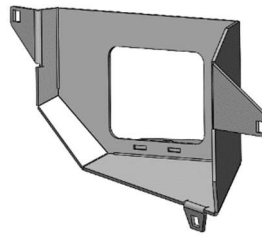

Passenger Side Fog Light Bucket

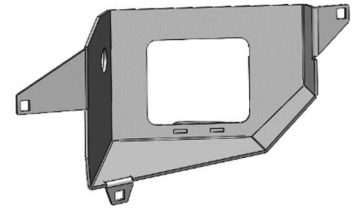

Driver Side Fog Light Bucket

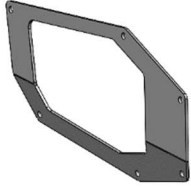

Passenger Side Fog Light Plate (No Sensor)

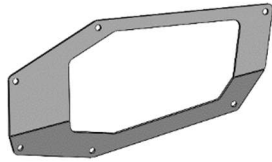

Driver Side Fog Light Plate (No Sensor)

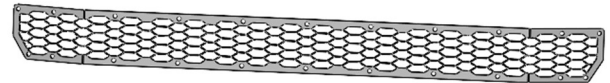

Center Mesh (No Sensor)

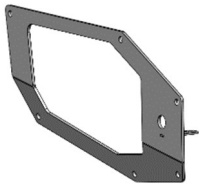

Passenger Side Fog Light Plate (Sensor)

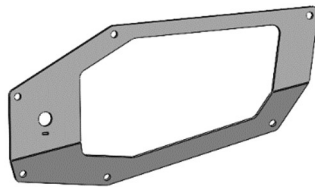

Driver Side Fog Light Plate (Sensor)

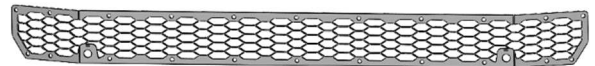

Center Mesh (Sensor)

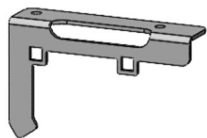

Upper Passenger Side Mesh Mount



Upper Center Mesh Mount

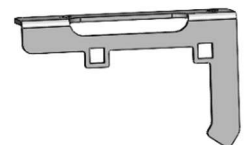

Upper Driver Side Mesh Mount

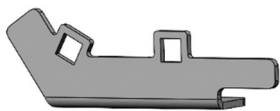

Lower Passenger Side Mesh Mount



Lower Center Mesh Mount

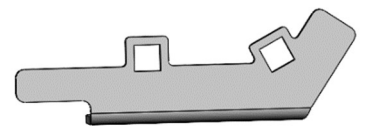

Lower Driver Side Mesh Mount

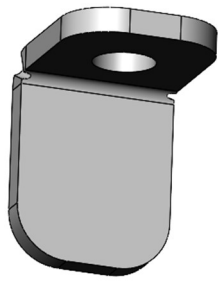

**Sensor Tabs x4**

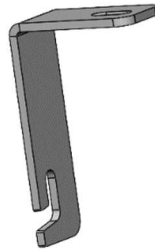

**Passenger Side Light Bar Bracket**

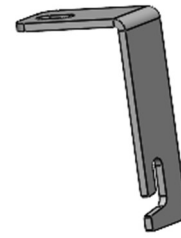

**Driver Side Light Bar Bracket**

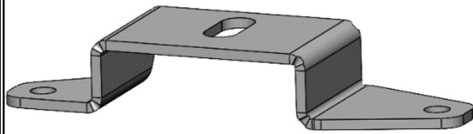

**Passenger Side Cube Light Bracket**

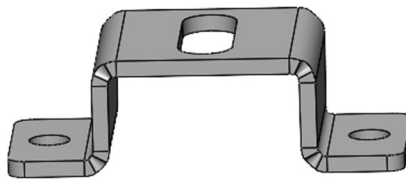

**Center Cube Light Bracket x6**

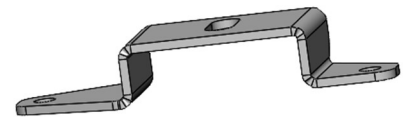

**Driver Side Cube Light Bracket x4**

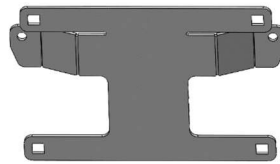

**License Plate Bracket**

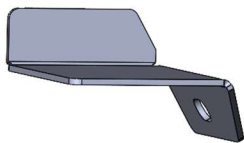

**Passenger Side Sensor Cover**

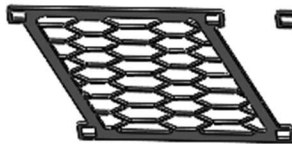

**Passenger Side Air Dam Mesh**

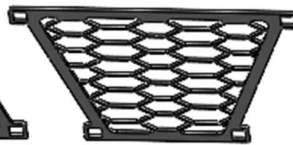

**Center Air Dam Mesh**

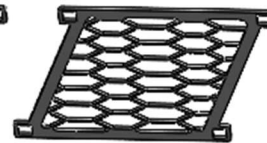

**Driver Side Air Dam Mesh**

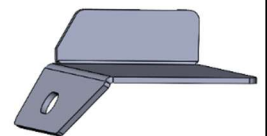

**Driver Side Sensor Cover**

# HARDWARE KIT

<b><u>Freedom Front License Plate</u></b>	<b><u>Qty:</u></b>
1/4-20 x 3/4 Long, Stainless Steel SBHCS	2
1/4-20 (.093-.126: Panel Range) Zinc Electroplate Spring Steel Cage Nut	2
Plastic License Plate Nuts	4
#14 x 5/8" Zinc License Plate Screw	4
<b><u>Freedom Front Light Bar and Mesh (Including Air Dam)</u></b>	<b><u>Qty:</u></b>
1/4-20 x 5/8 Long, Stainless Steel SBHCS	50
1/4-20 Hex Grade 5 Serrated Flange Nut, Stainless Steel	20
1/4-20 (.093-.126: Panel Range) Zinc Electroplate Spring Steel Cage Nut	30
<b><u>Freedom Front Formed Sport Bar</u></b>	<b><u>Qty:</u></b>
1/4-20 x 5/8 Long, Stainless Steel SBHCS	6
1/4-20 Hex Grade 5 Serrated Flange Nut, Stainless Steel	4
1/4-20 (.093-.126: Panel Range) Zinc Electroplate Spring Steel Cage Nut	2
<b><u>Freedom Front Fog Light Assembly</u></b>	<b><u>Qty:</u></b>
1/4-20 x 5/8 Long, Stainless Steel SBHCS	12
1/4-20 (.093-.126: Panel Range) Zinc Electroplate Spring Steel Cage Nut	12
<b><u>Freedom Front Intercooler Mount</u></b>	<b><u>Qty:</u></b>
5/16"-18 x 1" Zinc Grade 5 Hex Bolt	4
5/16"-18 Zinc Grade 8 Serrated Hex Flange Nut	4
5/16" Zinc Grade 5 Flat Washer	8
1/4-20 x 3/4 Long, Stainless Steel SBHCS	4
1/4-20 Hex Grade 5 Serrated Flange Nut, Stainless Steel	4
<b><u>Freedom Front Sensor Brackets and Covers</u></b>	<b><u>Qty:</u></b>
1/4-20 x 5/8 Long, Stainless Steel SBHCS	6
1/4-20 Hex Grade 5 Serrated Flange Nut, Stainless Steel	6
<b><u>Wing Support Brace</u></b>	<b><u>Qty:</u></b>
1/4-20 x 5/8 Long, Stainless Steel SBHCS	8
1/4-20 (.093-.126: Panel Range) Zinc Electroplate Spring Steel Cage Nut	8
<b><u>Freedom Front 3x3 Cube Light Mounts</u></b>	<b><u>Qty:</u></b>
1/4-20 x 5/8 Long, Stainless Steel SBHCS	16
1/4-20 Hex Grade 5 Serrated Flange Nut, Stainless Steel	16
<b><u>Freedom Front Mount Kit 2020-24 CHEVY HD</u></b>	<b><u>Qty:</u></b>
1/2" Washer, Grade 8 Zinc-Yellow	8
1/2"-13 Grade 8 Steel Serrated Flange Nut Zinc	8
1/2"-13 x 1-1/2" Zinc Tear Drop Bolt (Hex)	8

# STYLE OPTIONS



Base

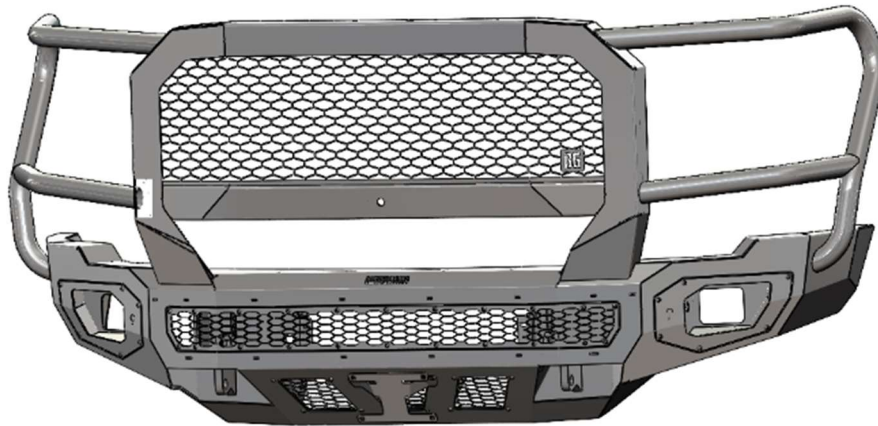

Extreme

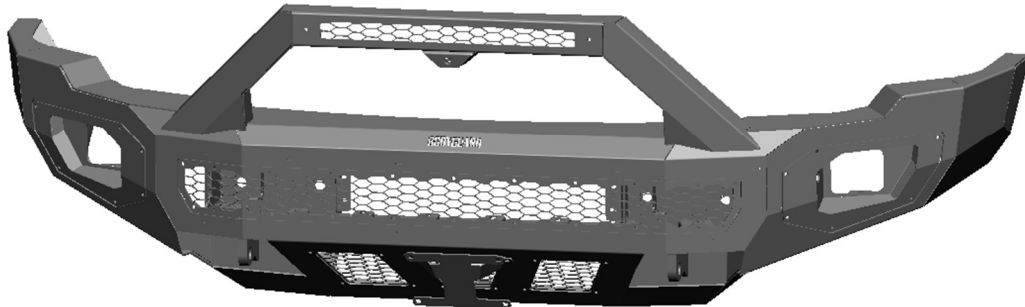

Sport

## CENTER LIGHT BAR CONFIGURATION *(Optional)*



Rigid 130313 E-Series - 30" Bar - Spot/Flood Combo Pattern



Rigid 130313 E-Series - 30" Bar - Spot/Flood Combo Pattern



Rigid 202113 D-Series Pro Cube - Flood Pattern - Surface Mount

1. 3x3 cube lights can be installed using the slotted holes in the brackets pictured in green.
2. 4x4 cube lights do not require the mounting brackets.
3. Also, light bar mount brackets (pictured in yellow) are included to allow the use of a 30" light bar.

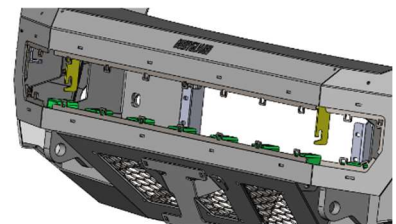
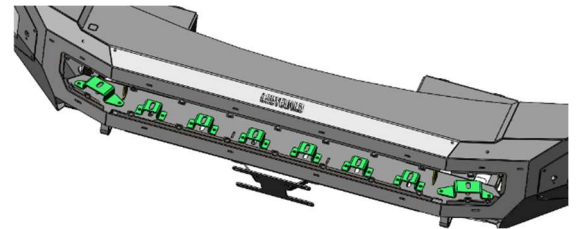

# FOG LIGHT INSTALLATION

1/4-20 Zinc Electroplate Spring Steel Cage Nut (6x)

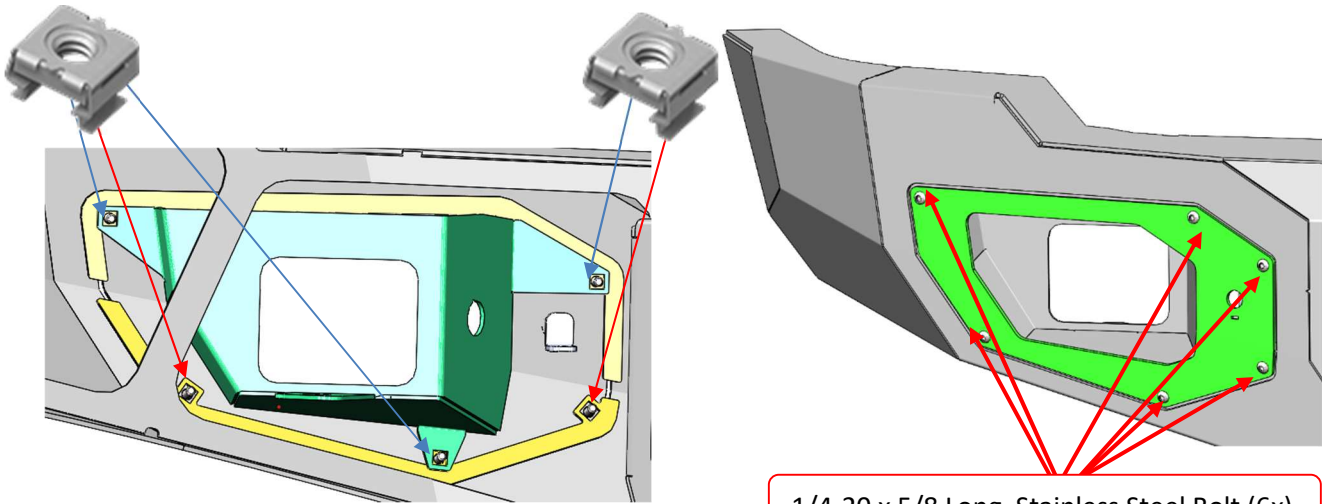

1/4-20 x 5/8 Long, Stainless Steel Bolt (6x)

# PARKING SENSOR INSTALL

1. Then install the sensor tab over the sensor shown below. Slide the sensor and sensor tab into position and tighten down with a 1/4"-20 x 3/4" BHCS. Plug the parking sensors into the harness and let the center mesh and fog light trim rings loosely hang down.

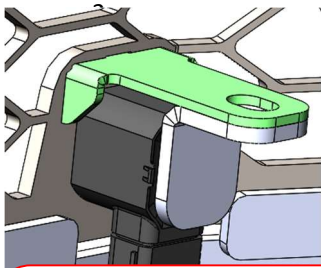

4x - 1/4-20 x 3/4 Long, Stainless Steel SBHCS



4x - 1/4-20 Hex Grade 5 Serrated Flange Nut, Stainless Steel

2. Install sensor covers on underside of bumper inside the shackle box using the 1/4" -20 x 5/8" Stainless Steel hardware.

1/4" -20 x 5/8" Stainless SBHCS

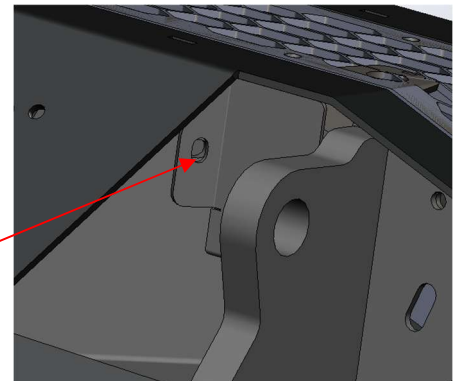

## MESH PLATE INSTALL

1. Mount brackets for the center mesh are bolt-on components. They should be installed with a total of 18 1/4-20 x 5/8 Long, Stainless Steel Bolts and hex nuts.
2. Install cage nuts into the appropriate holes in the air dam mesh components (12 nuts) and center mesh mount brackets (18 nuts).
3. Use provided 1/4-20 x 5/8 Long, Stainless Steel Bolts (30) to secure mesh plates.

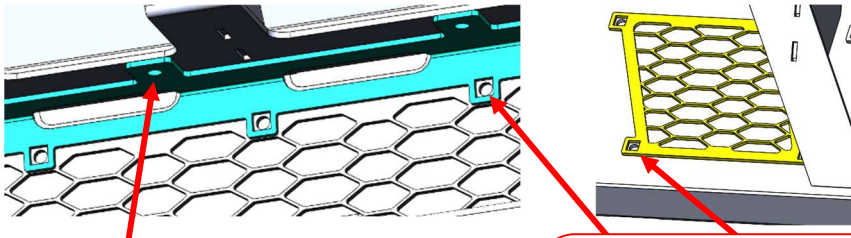

18x - 1/4-20 x 5/8 Long, Stainless Steel SBHCS



18x - 1/4-20 Hex Grade 5 Serrated Flange Nut, Stainless Steel



30x - 1/4-20 (.093-.126: Panel Range) Zinc Electroplate Spring Steel Cage Nut



30x - 1/4-20 x 5/8 Long, Stainless Steel SBHCS

## LICENSE PLATE INSTALL

1. Install two 1/4"-20 Cage Nuts into square holes, then the install license plate bracket to the skid plate using two 1/4"-20 x 5/8" button head screws

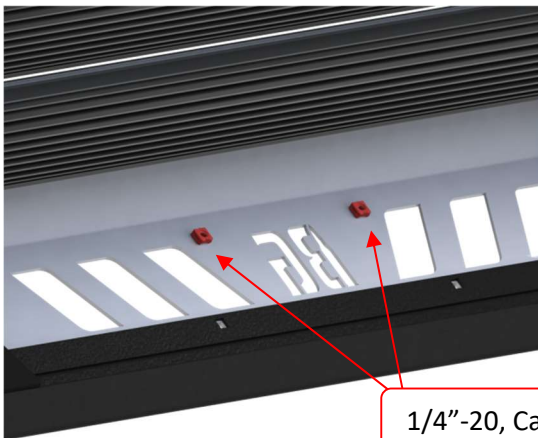

1/4"-20, Cage Nut



1/4"-20 x 5/8", SBHCS

## Engine Block Heater Plug Install

1. A port hole has been included in the driver side fog mount light to install the engine block heater plug. Use factory hardware to install as needed.

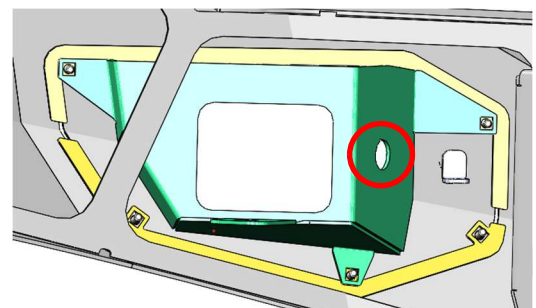

# INTERCOOLER INSTALL

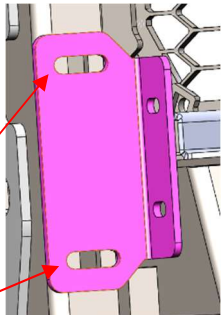

- 2x - 5/16"-18 x 1" Yellow Zinc Grade 8 Hex Bolt
- 4x - 5/16" Yellow Zinc Grade 8 Flat Washer
- 2x - 5/16"-18 Zinc Grade 8 Serrated Hex Flange

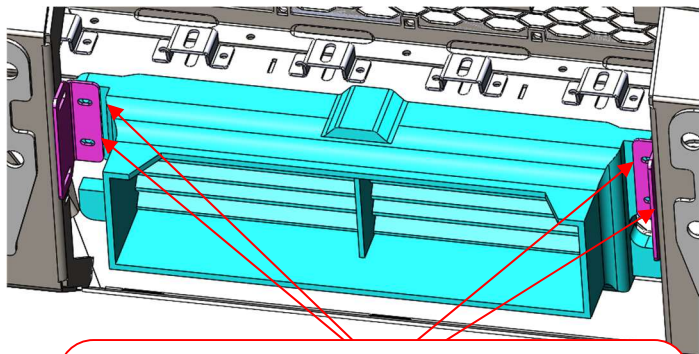

- 4x - 1/4-20 x 3/4 Long, Stainless Steel SBHCS
- 4x - 1/4-20 Hex Grade 5 Serrated Flange Nut, Stainless Steel

1. First attach provided brackets to the bumper mount frame as shown with 5/16" -16 x1" Yellow Zinc hardware.
2. Next attach intercooler to brackets with 1/4 - 20 x 3/4 Stainless hardware.

# Extreme Camera Install

1. Secure the camera cradle (pictured in green) loosely to the camera mount (yellow) with **2x (1/4-20 x 5/8 Long, Stainless Steel SBHCS)**.
2. Loosely attach the completed assembly to the center channel using **2x (1/4-20 x 5/8 Long, Stainless Steel SBHCS)**.
3. Place the camera into the cradle and position it properly with the hole in the front of the center channel.
4. The camera washing system will be installed through the welded in spacers (pictured in red).
5. Install the camera bracket (pictured in blue) with **2x (1/4-20 x 5/8 Long, Stainless Steel SBHCS)**.
6. Ensure everything is properly aligned and tighten all screws.
7. If you do not have a camera, we provide a camera hole plug that can be installed in the hole.

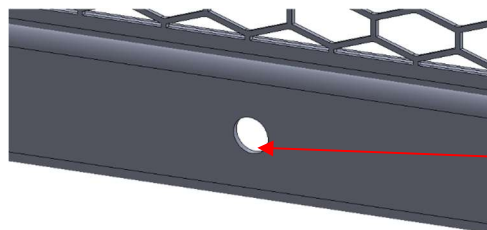
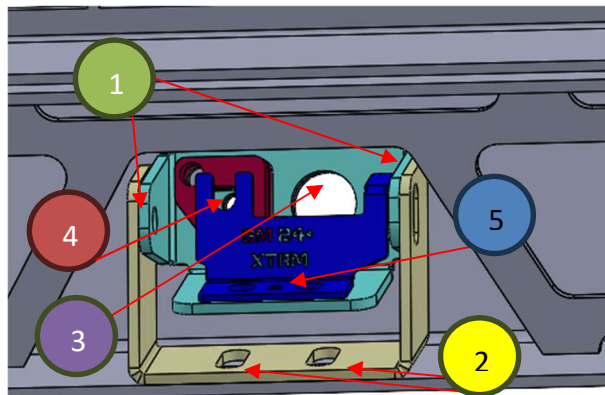

## SPORT BAR CAMERA INSTALL(For optional sport bar only)

1. Install the camera pod to the sport bar using (2) 1/4"-20 cage nuts and (2) 1/4"-20 x 3/4" BHCS. Then install the camera into the pod and secure with the camera bracket using (2) 1/4"-20 BHCS and flange nuts.

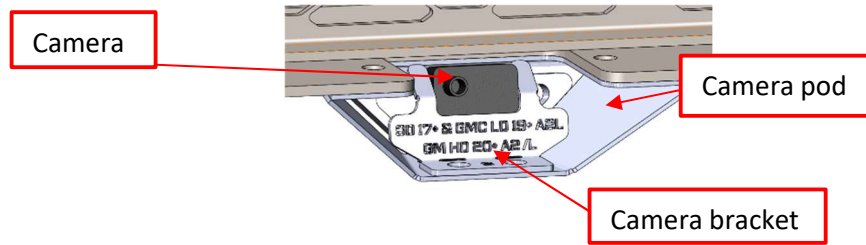

2. Then install the sport bar mesh using 2x 1/4"-20 x 3/4" BHCS and flange nuts. Then install your light bar using the light bar brackets if applicable.

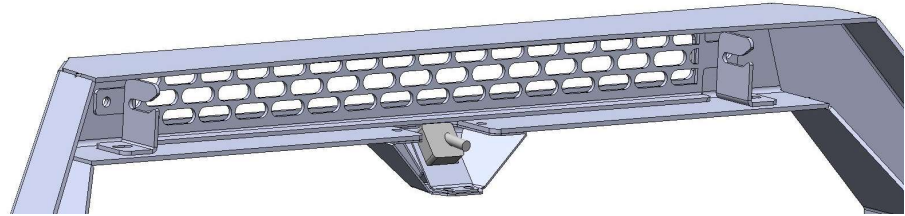

## MOUNT INSTALL

1. Attach the truck mounts with the 1/2"-13x 1-1/2" Zinc Tear Drop Bolt (Hex), leaving enough space to adjust as needed.

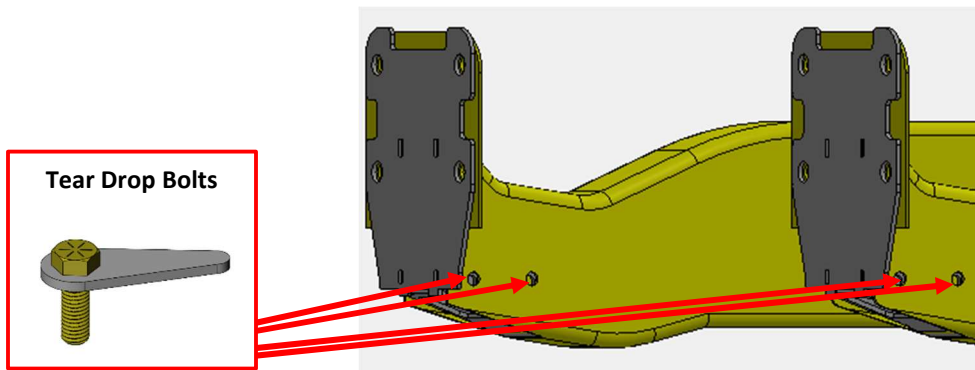

# BUMPER INSTALLATION

1. Attach the bumper with the factory hardware, leaving enough space to adjust the bumper as needed into position. Using a tape measure, adjust the bumper vertically and horizontally to the desired body gaps. Once the bumper is lined up, tighten all hardware for the bumper and the mounts. Using jack stands or an additional person to help support the bumper is recommended.



**Factory bolts  
GM #11569664**

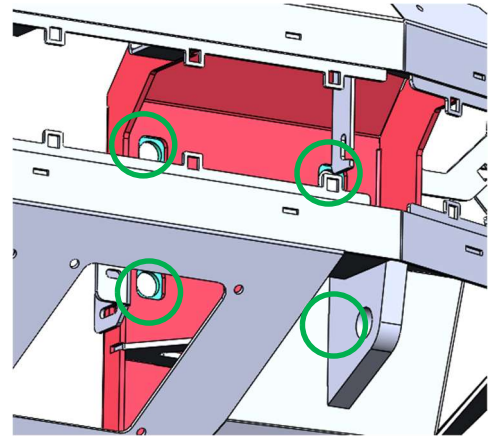

# SAFETY

## THE SAFETY OF YOU AND OTHERS IS VERY IMPORTANT TO US!

To minimize this risk and make an informed decision about safety, it is important that you carefully read and follow the installation instructions we have provided.

We urge you to use your own good judgment and allow plenty of time for installation.

# HAZARD CHECKLIST

1. Always wear personal protective equipment (PPE) such as: protective eye wear, gloves, close toed shoes, etc.
2. We recommend that you use a certified mechanic or shop for professional installation.
3. Always set emergency brakes on the vehicle and use tire blocks to ensure vehicle stabilization.
4. Use caution when lifting, we recommend the use of equipment to help lift bumpers into place.
5. Use caution when using power tools such as air ratchet, etc.
6. Take caution when installing wiring.
7. Perform regular inspections of hardware, bolts, brackets, etc.
8. Rigid light brackets are specifically designed to fit Rigid lights, we do not guarantee off brand fitment.
9. Our winch mount is designed for Warn and Superwinch products. We do not guarantee off-brand fitment.

# USE & RISK

Bodyguard Products LLC is not responsible for damage to our products, or other subsequent damage that might occur because of misuse or improper installation. While we do manufacture products that appear stronger than factory parts, our products should not be viewed or relied upon as life-saving devices in the event of a collision or rollover. We make no claims relating to airbag compatibility, crashworthiness, or sturdiness. It is the customer's responsibility to check with the vehicle manufacturer or auto dealer regarding airbag compatibility and automobile manufacturer's warranty before installing our products.

# FINISHING UP

- Install shackles.
- Confirm that all hardware is tightened, and everything is secure.
- Secure wiring harnesses for lights and sensors.
- Test all lighting and wiring before using vehicle (fog lights, sensors, etc.).

# MAINTENANCE

- 1) Periodically check that all hardware is tightened and that all wiring and connections are secure.
- 2) Periodically check that all sensor plugs are secure.
- 3) Routinely wash bumper to maintain the powder coat finish.

# FEEDBACK

We'd love to hear from you!

Please send your pictures, testimonials, comments, or suggestions to us by email at [info@bodyguardbumpers.com](mailto:info@bodyguardbumpers.com). We frequently use customer pictures for brochures and marketing materials, and we always welcome customer feedback to ensure quality improvements within our company. Thanks for your purchase; we appreciate your business very much!

Where **STRENGTH** Meets *Style!*™



@BodyguardBumpers